

Metallized Polyester Film Capacitor Related Document: IEC 60384-2

MAIN APPLICATIONS:

Blocking, bypassing, filtering, timing, coupling and decoupling circuits, interference suppression in low voltage applications. High temperature operations.

MARKING:

Manufacturer's logo/type/C-Value/rated voltage/tolerance/date of manufacture

DIELECTRIC:

Polyester film

ELECTRODES:

Vacuum deposited aluminum

COATING:

Flame retardant plastic case (UL-class 94 V-0), green, epoxy resin sealed

CONSTRUCTION:

Extended metallized film (refer to general information)

LEADS:

Tinned wire

IEC TEST CLASSIFICATION:

55/125/56, according to IEC 60068

TEMPERATURE RANGE:

- 55°C to + 125°C

CAPACITANCE RANGE:

1000pF to 15µF

CAPACITANCE TOLERANCES:

± 20% (M), ± 10% (K), ± 5% (J)

RATED VOLTAGES (U_R):

63 VDC, 100 VDC, 250 VDC, 400 VDC, 630 VDC, 1000 VDC

PERMISSIBLE AC VOLTAGES (RMS) UP TO 60Hz:

40 VAC, 63 VAC, 160 VAC, 200 VAC, 220 VAC, 220 VAC

TEST VOLTAGE (ELECTRODE/ELECTRODE):

1.6 x U_R for 2 s

INSULATION RESISTANCE:

Measured at 100 VDC (63 VDC series measured at 50 VDC) after one minute

MAXIMUM PULSE RISE TIME

PCM (mm)	Maximum Pulse Rise Time d _v /d _t [V/µs]					
	63 VDC	100 VDC	250 VDC	400 VDC	630 VDC	1000 VDC
10	6	9	18	26	35	130
15	4	5	10	16	33	65
22.5	2.5	3	6	9	19	34
27.5	—	2.5	5	7	14	25

If the maximum pulse voltage is less than the rated voltage higher d_v/d_t values can be permitted.

DISSIPATION FACTOR TAN δ

MEASURED AT	C ≤ 0.1µF	0.1µF < C ≤ 1.0µF	C > 1.0µF
1kHz	8 x 10 ⁻³	8 x 10 ⁻³	10 x 10 ⁻³
10kHz	15 x 10 ⁻³	15 x 10 ⁻³	—
100kHz	25 x 10 ⁻³	—	—
		Maximum values	

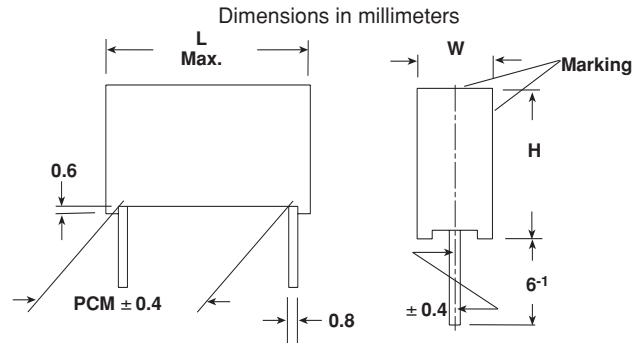

For C ≤ 0.33µF and U_R > 100 VDC:
30,000 MΩ minimum value (100,000 MΩ typical value)
For C ≤ 0.33µF and U_R ≤ 100 VDC:
15,000 MΩ minimum value (50,000 MΩ typical value)

TIME CONSTANT:

Measured at 100 VDC (63 VDC series measured at 50 VDC) after one minute

For C > 0.33µF and U_R > 100 VDC:
10,000 s minimum value (40,000 s typical value)

For C > 0.33µF and U_R ≤ 100 VDC:
5000 s minimum value (15,000 s typical value)

CAPACITANCE DRIFT:

Up to + 40°C, ± 1.5% for a period of two years

DERATING FOR DC AND AC. CATEGORY VOLTAGE U_C:

At + 85°C: U_C = 1.0 U_R

At + 100°C: U_C = 0.8 U_R

At + 125°C: U_C = 0.5 U_R (maximum 1000 h)

SELF INDUCTANCE:

~ 6 nH measured with 2mm long leads

PULL TEST ON LEADS:

≥ 30 N in direction of leads according to IEC 60068-2-21

RELIABILITY:

Operational life > 300,000 h

Failure rate < 2 FIT (40°C and 0.5 x U_R)

For further details, please refer to the general information provided in this catalog.



CAPACITANCE	CAPACITANCE CODE	VOLTAGE CODE 06 63 VDC/40 VAC				VOLTAGE CODE 01 100 VDC/63 VAC				VOLTAGE CODE 25 250 VDC/160 VAC			
		W	H	L	PCM	W	H	L	PCM	W	H	L	PCM
1000 pF	- 210	—	—	—	—	—	—	—	—	—	—	—	—
1500 pF	- 215	—	—	—	—	—	—	—	—	—	—	—	—
2200 pF	- 222	—	—	—	—	—	—	—	—	—	—	—	—
3300 pF	- 233	—	—	—	—	—	—	—	—	—	—	—	—
4700 pF	- 247	—	—	—	—	—	—	—	—	—	—	—	—
6800 pF	- 268	—	—	—	—	—	—	—	—	—	—	—	—
0.01 μF	- 310	—	—	—	—	—	—	—	—	—	—	—	—
0.015 μF	- 315	—	—	—	—	—	—	—	—	—	—	—	—
0.022 μF	- 322	—	—	—	—	—	—	—	—	3.5	8.0	13.0	10
0.033 μF	- 333	—	—	—	—	—	—	—	—	3.5	8.0	13.0	10
0.047 μF	- 347	—	—	—	—	—	—	—	—	3.5	8.0	13.0	10
0.068 μF	- 368	—	—	—	—	3.5	8.0	13.0	10	3.5	8.0	13.0	10
0.10 μF	- 410	—	—	—	—	3.5	8.0	13.0	10	4.5	9.5	13.0	10
0.15 μF	- 415	—	—	—	—	3.5	8.0	13.0	10	5.5	10.5	13.0	10
0.22 μF	- 422	3.5	8.0	13.0	10	3.5	8.0	13.0	10	6.5	11.5	13.0	10
0.33 μF	- 433	3.5	8.0	13.0	10	4.0	9.0	13.0	10	5.5	10.5	18.0	15
0.47 μF	- 447	3.5	8.0	13.0	10	4.5	9.5	13.0	10	6.5	12.5	18.0	15
0.68 μF	- 468	4.0	9.0	13.0	10	5.5	10.5	13.0	10	7.5	13.5	18.0	15
1.0 μF	- 510	4.5	9.5	13.0	10	5.5	10.5	18.0	15	8.5	14.5	18.0	15
1.5 μF	- 515	5.5	10.5	13.0	10	6.5	12.5	18.0	15	8.5	16.5	26.5	22.5
2.2 μF	- 522	6.5	11.5	13.0	10	6.5	12.5	18.0	15	10.5	18.5	26.5	22.5
3.3 μF	- 533	6.5	12.5	18.0	15	8.5	14.5	18.0	15	12.5	20.0	26.5	22.5
4.7 μF	- 547	7.5	13.5	18.0	15	7.5	15.5	26.5	22.5	13.5	23.5	31.5	27.5
6.8 μF	- 568	8.5	14.5	18.0	15	8.5	16.5	26.5	22.5	—	—	—	—
10.0 μF	- 610	8.5	17.5	18.0	15	10.5	18.5	26.5	22.5	—	—	—	—
15.0 μF	- 615	8.5	16.5	26.5	22.5	11.5	20.5	31.5	27.5	—	—	—	—

Further values upon request.

RECOMMENDED PACKAGING

LETTER CODE	TYPE OF PACKAGING	HEIGHT (H) (mm)	REEL DIAMETER (mm)	ORDERING CODE EXAMPLES	PCM	PCM	PCM
					10	15	22.5 - 27.5
D	AMMO	16.5	S*	MKT 1820-422/065-D	X	X	—
G	AMMO	18.5	S*	MKT 1820-422/065-G	X	X	—
F	REEL	16.5	350	MKT 1820-422/065-F	X	X	—
W	REEL	18.5	350	MKT 1820-422/065-W	X	X	—
V	REEL	18.5	500	MKT 1820-610/015-V	—	X	X
G	AMMO	18.5	L*	MKT 1820-610/015-G	—	—	X
—	BULK	—	—	MKT 1820-615/015	X	X	X

*S = box size 55 x 210 x 340mm (W x H x L)

*L = box size 60 x 360 x 510mm (W x H x L)



CAPACITANCE	CAPACITANCE CODE	VOLTAGE CODE 40 400 VDC/200 VAC				VOLTAGE CODE 63* 630 VDC/220 VAC				VOLTAGE CODE 10* 1000 VDC/220 VAC			
		W	H	L	PCM	W	H	L	PCM	W	H	L	PCM
1000 pF	- 210	—	—	—	—	3.5	8.0	13.0	10	4.0	9.0	13.0	10
1500 pF	- 215	—	—	—	—	3.5	8.0	13.0	10	4.0	9.0	13.0	10
2200 pF	- 222	—	—	—	—	3.5	8.0	13.0	10	4.0	9.0	13.0	10
3300 pF	- 233	—	—	—	—	3.5	8.0	13.0	10	4.0	9.0	13.0	10
4700 pF	- 247	—	—	—	—	3.5	8.0	13.0	10	5.5	10.5	13.0	10
6800 pF	- 268	—	—	—	—	3.5	8.0	13.0	10	6.5	11.5	13.0	10
0.01 μF	- 310	3.5	8.0	13.0	10	4.0	9.0	13.0	10	5.5	10.5	18.0	15
0.015 μF	- 315	3.5	8.0	13.0	10	4.5	9.5	13.0	10	6.5	12.5	18.0	15
0.022 μF	- 322	3.5	8.0	13.0	10	5.5	10.5	13.0	10	7.5	13.5	18.0	15
0.033 μF	- 333	4.0	9.0	13.0	10	5.5	10.5	18.0	15	6.5	14.5	26.5	22.5
0.047 μF	- 347	4.5	9.5	13.0	10	6.5	12.5	18.0	15	7.5	15.5	26.5	22.5
0.068 μF	- 368	5.5	10.5	13.0	10	7.5	13.5	18.0	15	8.5	16.5	26.5	22.5
0.10 μF	- 410	6.5	11.5	13.0	10	6.5	14.5	26.5	22.5	10.5	18.5	26.5	22.5
0.15 μF	- 415	6.5	12.5	18.0	15	7.5	15.5	26.5	22.5	11.5	20.5	31.5	27.5
0.22 μF	- 422	6.5	12.5	18.0	15	8.5	16.5	26.5	22.5	13.5	23.5	31.5	27.5
0.33 μF	- 433	7.5	13.5	18.0	15	11.5	20.5	31.5	27.5	16.5	29.5	31.5	27.5
0.47 μF	- 447	8.5	17.5	18.0	15	11.5	20.5	31.5	27.5	20.0	35.0	31.5	27.5
0.68 μF	- 468	8.5	16.5	26.5	22.5	13.5	23.5	31.5	27.5	—	—	—	—
1.0 μF	- 510	10.5	18.5	26.5	22.5	15.0	24.5	31.5	27.5	—	—	—	—
1.5 μF	- 515	11.5	20.5	31.5	27.5	—	—	—	—	—	—	—	—
2.2 μF	- 522	13.5	23.5	31.5	27.5	—	—	—	—	—	—	—	—

Further C-values upon request.

*Not suitable for mains applications.

Please refer to X-capacitors in our catalog "RFI Suppression Components".

RECOMMENDED PACKAGING

LETTER CODE	TYPE OF PACKAGING	HEIGHT (H) (mm)	REEL DIAMETER (mm)	ORDERING CODE EXAMPLES	PCM	PCM	PCM
					10	15	22.5 - 27.5
D	AMMO	16.5	S*	MKT 1820-410/405-D	X	X	—
G	AMMO	18.5	S*	MKT 1820-410/405-G	X	X	—
F	REEL	16.5	350	MKT 1820-410/405-F	X	X	—
W	REEL	18.5	350	MKT 1820-410/405-W	X	X	—
V	REEL	18.5	500	MKT 1820-422/635-V	—	X	X
G	AMMO	18.5	L*	MKT 1820-422/635-G	—	—	X
—	BULK	—	—	MKT 1820-515/405	X	X	X

*S = box size 55 x 210 x 340mm (W x H x L)

*L = box size 60 x 360 x 510mm (W x H x L)

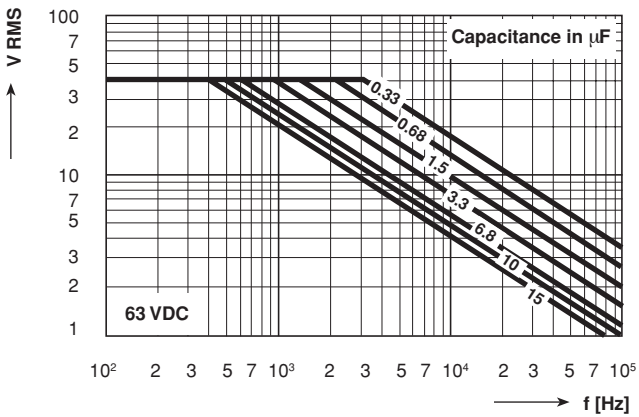

Permissible AC Voltage versus Frequency

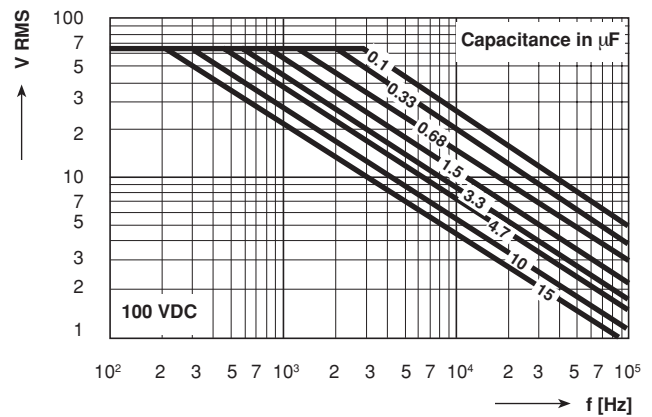

Permissible AC Voltage versus Frequency

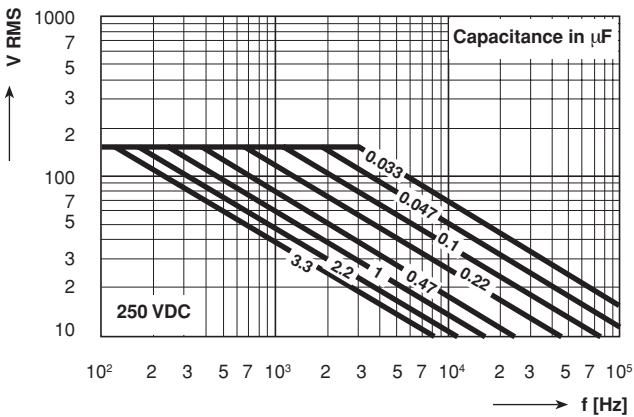

Permissible AC Voltage versus Frequency

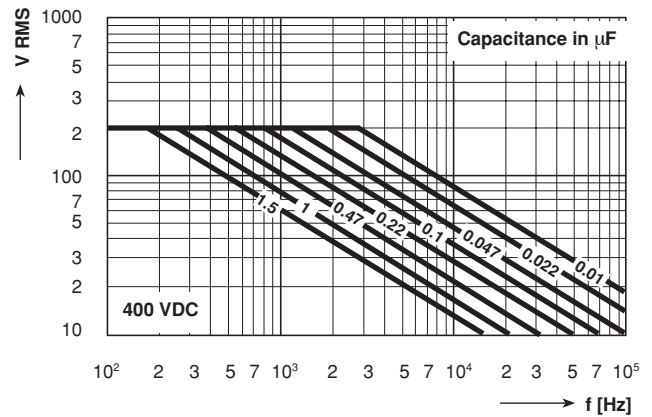

Permissible AC Voltage versus Frequency

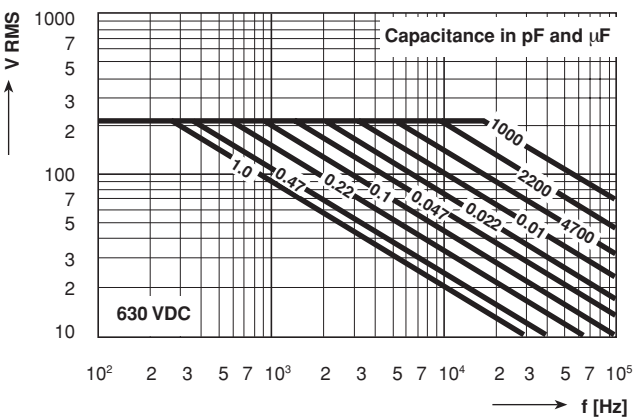

Permissible AC Voltage versus Frequency

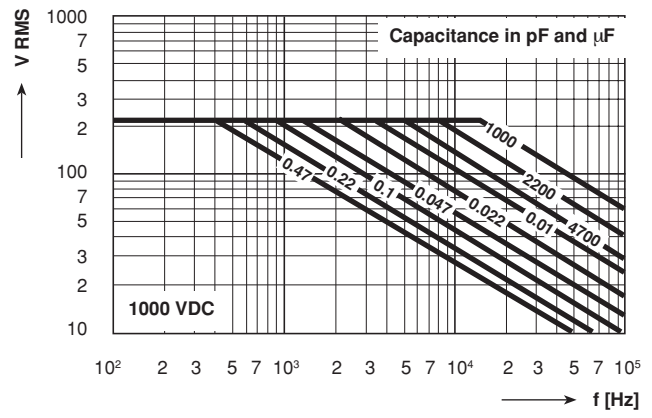

Permissible AC Voltage versus Frequency